

Mercedes

- ⊕ G-Modell
- ⊕ B-Klasse
- ⊕ M-Klasse
- ⊕ SLK
- ⊕ E-Klasse
- ⊕ Sprinter mittel (X)
- ⊕ smart
- ⊕ R-Klasse
- ⊕ CLK
- ⊕ Vito (X)
- ⊕ S-Klasse lang

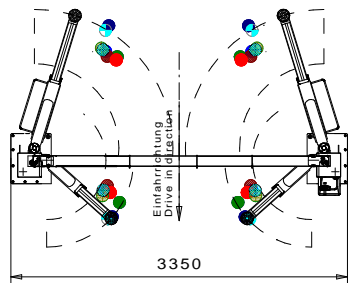

AUDI

- ⊕ AUDI Q7 (X)
- ⊕ AUDI Q5
- ⊕ AUDI A5
- ⊕ A2
- ⊕ A3 2004
- ⊕ Audi TT
- ⊕ A8 lang
- ⊕ AUDI R8 *
- ⊕ Cressida
- ⊕ Toyota IQ
- ⊕ Yaris (2000)
- ⊕ Land Cruiser (GX-R)
- ⊕ A2
- ⊕ A3 2004
- ⊕ Audi TT
- ⊕ A8 lang
- ⊕ AUDI R8 *
- ⊕ Hiace (short)

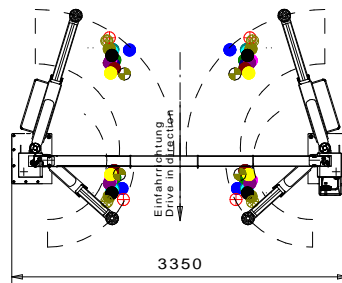

Toyota

- ⊕ Yaris
- ⊕ MX-81/MX-83 1989-1992
- ⊕ Crowm 1996-1999
- ⊕ Corolla ab 2004
- ⊕ XA seit 2004
- ⊕ Avensis
- ⊕ Camry
- ⊕ Landcruiser

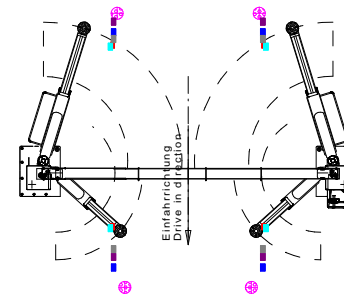

Verschiedene

- ⊕ Citroen Jumper (Radstand 4035) (X)
- ⊕ Rolls Royce RR-02/03
- ⊕ RollsRoyce RR-04
- ⊕ RollsRoyce RR-01 L (lang) (X)
- ⊕ RollsRoyce RR-01 L EWB Serie II (X)
- ⊕ RollsRoyce RR-01 (X)

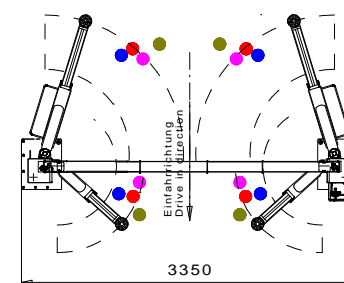

Ford

- ⊕ Ford Fiesta
- ⊕ Ford Mondeo
- ⊕ Ford Explorer (X)
- ⊕ Ford Maverik

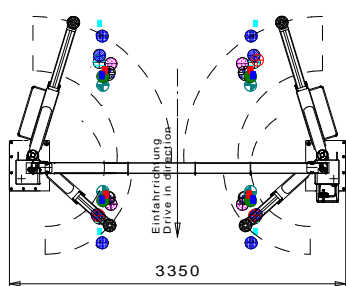

BMW

- ⊕ BMW E52 Z8
- ⊕ BMW E39 5er
- ⊕ BMW Z1
- ⊕ Mini Cooper
- ⊕ E65 7er BMW
- ⊕ BMW 3er
- ⊕ RR01 (X)
- ⊕ BMW Z4
- ⊕ BMW 750i E38
- ⊕ BMW G12 (X)
- ⊕ BMW F45 2er
- ⊕ BMW F36 4er

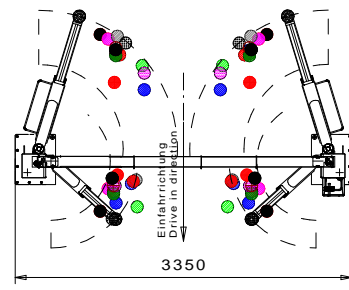

Porsche

- ⊕ GT2
- ⊕ Boxster Typ 986
- ⊕ 911 bis Modell 86 (X)
- ⊕ 911 ab Modell 87
- ⊕ 928 bis Modell 85
- ⊕ 928 ab Modell 86
- ⊕ 968
- ⊕ 959
- ⊕ Boxster// 911 Carrera (996)
- ⊕ 4-Zylinder Baureihe
- ⊕ Cayenne
- ⊕ Macan
- ⊕ Panamera 970
- ⊕ 911 Carrera S

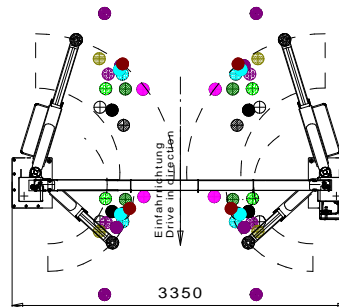

Allgemein

- ⊕ Megane II
- ⊕ Nissan GTR
- ⊕ Peugeot 207 SW
- ⊕ Peugeot Boxer lang (X)
- ⊕ Ford Fiesta
- ⊕ Fiat 500
- ⊕ Landrover Defender 110 300TDI (X)
- ⊕ LS600
- ⊕ Smart Fortwo vor 2014
- ⊕ Smart Fortwo ab 2014
- ⊕ Lamborghini LP700
- ⊕ Lamborghini LP 610-4
- ⊕ Lamborghini Gallardo

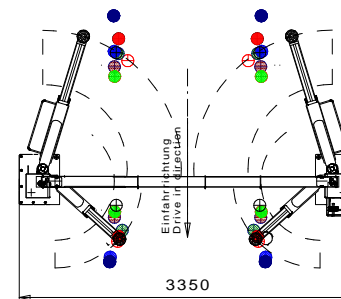

VW

- ⊕ Touran
- ⊕ Pheaton
- ⊕ Touareg/Cayenne
- ⊕ VW T4 kurz (X)
- ⊕ VW T5 kurz (X)
- ⊕ VW T5 lang (X)
- ⊕ Seat Leon / Altea
- ⊕ Seat Toledo

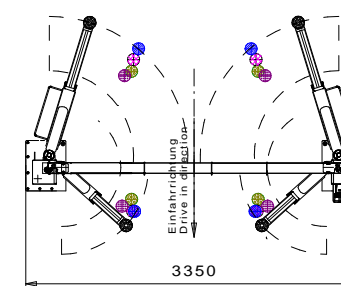

OPEL

- ⊕ Opel Agila
- ⊕ Opel Corsa
- ⊕ Opel Vectra Combi 2007
- ⊕ Opel Insignia

(X) Fahrzeug kann nicht aufgenommen werden

Alle Maße in mm!
Mass- und Konstruktionsänderungen vorbehalten / Subject to alterations!

| | | Datum | Name | Benennung |
|----|----------------------|-----------------|------|------------------------------------------------------------------|
| | | Bearb. 31.03.17 | mh | HL 2.35 NT SC Tragfähigkeit / capacity: 3500kg SC-Tragarme |
| - | - | Gepr. | | |
| - | - | Norm | | |
| | | | | Zeichnungsnummer |
| b | div. Fahrzeuge hinzu | 04.04.17 | mh | 8570_NB |
| a | Tragarmzug hinzu | 04.04.17 | mh | |
| Nr | Änderung | Datum | Name | Urspr. |
| | | | | Ersatz fuer: |
| | | | | Ersatz durch: |

Nussbaum