

SOLLEVATORE A CILINDRI INTERRATI A 2 PISTONI

TOP LIFT 2.35 TLK

VERSIONE AD INCASSO

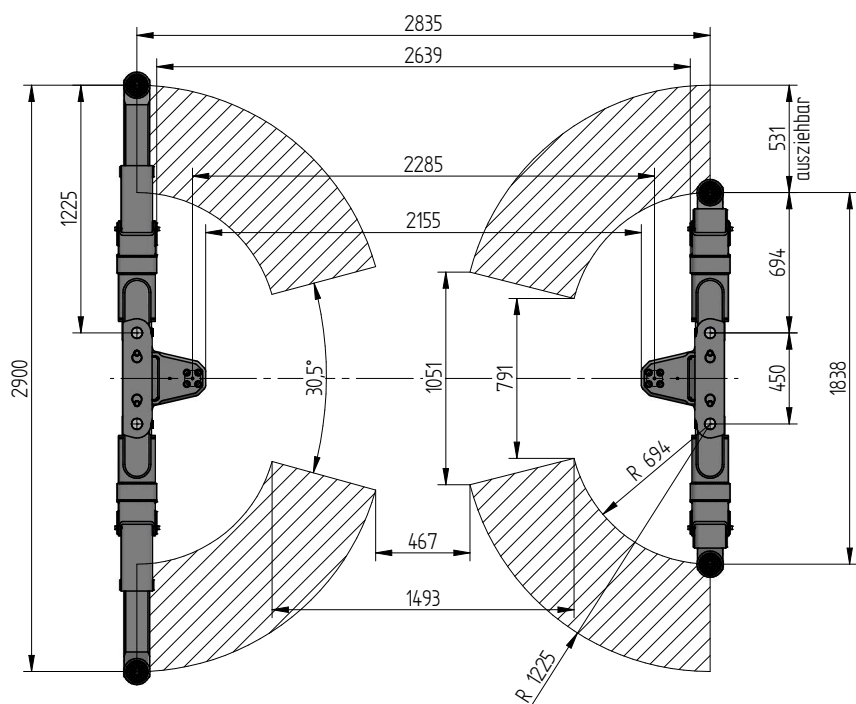

DATI TECNICI

Portata	3500 kg
Altezza di sollevamento	2048 mm
Altezza max. tampone	90 mm
Diametro pistone	123 mm
Distanza pistoni	2285 mm
Profondita' di installazione	2408 mm
Assorbimento motore	3,0 kW
Alimentazione	400 V/16 A
Lunghezza cavi	11 m
Tempo di sollevamento	≈ 35 sec.
Tempo di discesa	≈ 35 sec.

Bracci 2.35 TLK 0015743

Installation cassette 2285 mm 0016795

Pistone di sollevamento 3,5 t 2285 mm - K pre-assemblato in fabbrica nella cassetta 0016793

Telaio di installazione 2.35 TLK 2285 0016796





ACCESSORI

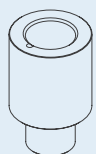

1

1 | Prolunga Tampone
89 mm
d 50 x 89 mm
0016747 (1 set / 4 pezzi)



2

2 | Prolunga Tampon
127 mm
d 50 x 127 mm
0016746 (1 set / 4 pezzi)

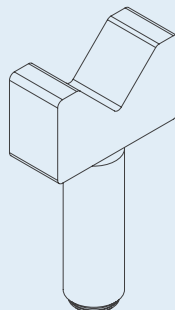

3

3 | Adattatore a V
d 50 / 87 - 130 mm
0016748 (1 set / 4
pezzi)

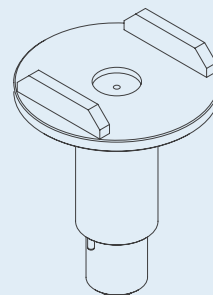

4

4 | Adattatore a U
d 50
0016749
(1 set / 4 pezzi)

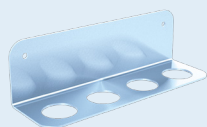

Supporto per
adattatori
0016751

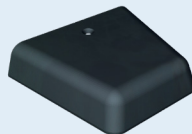

Protezione Cerchi
0015746 (1 set / 2 pezzi)

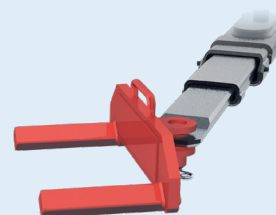

Forca per solleva-
mento sottoruota
0016752 (1Set / 4 pezzi)